

# LETO 11.5

## SURFACE CONDUIT LED CYLINDER



### Features

- Faceted and Smooth metal reflectors provide beam spreads between 10° to 80°.
- Nine drivers selections available to cover wide range of applications.
- Three output options available up to 1500 lumens.
- 5 year warranty.



### Finish Options

- White
- Mocha
- Black
- Charcoal
- Silver
- Cerulean
- Firebrick



### Technical Information

OUTPUT OPTIONS	700 lm	1000 lm	1500 lm
<b>Fixture wattage</b>	6.1 W	9.1 W	14.0 W
<b>Delivered Lumen at 3500K</b>	647 lm	965 lm	1474 lm
<b>Efficacy</b>	106 lm/W	106 lm/W	105 lm/W
<b>Center Beam Candlepower (10° Faceted Reflector)</b>	5399 cd	8052 cd	12300 cd

CCT	Multiplier	CRI	TM-30		
			R <sub>f</sub>	R <sub>g</sub>	R <sub>9</sub>
<b>2500K</b>	0.81	92	90	104	77
<b>2700K</b>	0.92	92	91	102	61
<b>3000K</b>	0.97	95	92	102	61
<b>3500K</b>	1.00	95	93	101	72
<b>4000K</b>	1.07	95	92	103	68
<b>6500K</b>	1.05	96	91	100	89

Integral Driver Example: Fixture LET115-SC-07-25K-F10-NA-WH-WH-PHSD-NA  
 Remote Driver Example: Fixture LET115-C-07-25K-F10-NA-WH-WH-010L-NA  
 HRM-LET115-C-07-25K-010L-NA

### Ordering Code

#### Fixture

MODEL	TYPE	OUTPUT	CCT	OPTIC	ACCESSORY	BODY FINISH	BAFFLE FINISH
LET115-Leto 11.5	SC-Surface Conduit	07-700 lumens (6.1W) 10-1000 lumens (9.1W) 15-1500 lumens (14.0W)	25K-2500K 27K-2700K 30K-3000K 35K-3500K 40K-4000K 65K-6500K	F10-10 Degree, Faceted F18-18 Degree, Faceted F30-30 Degree, Faceted F45-45 Degree, Faceted F60-60 Degree, Faceted S30-30 Degree, Smooth S45-45 Degree, Smooth S80-80 Degree, Smooth	NA-No Accessory CL-Clear Lens DL-Diffusing Lens HC-Honeycomb Louver SL-Solite Lens	<b>Standard</b> WH-White BK-Black SL-Silver  <b>Premium<sup>1</sup></b> MA-Mocha CC-Charcoal CR-Cerulean FB-Firebrick	<b>Standard</b> WH-White BK-Black SL-Silver  <b>Premium<sup>1</sup></b> MA-Mocha CC-Charcoal CR-Cerulean FB-Firebrick

#### DRIVER

#### DRIVER OPTIONS<sup>2</sup>

- PHSD-Forward/Reverse Phase, 1% Dimming, 120V Only
- 010S-0-10V, 1% Dimming, 120/277V
- 0103-0-10V, 1% Dimming, 347V Only
- 010L-EldoLED, 0-10V, Linear, 0.1% Dimming, 120/277V
- 010G-EldoLED, 0-10V, Log, 0.1% Dimming, 120/277V
- DALI-EldoLED, DALI Protocol 2, DT-6, 0.1% Dimming, 120/277V
- DALI8-EldoLED, DALI Protocol 2, DT-8, 0.1% Dimming, 120/277V
- LUTE-Lutron Hslume Ecodigital, 1% Dimming, 120V/277V
- DMX-EldoLED, DMX, 0.1% Dimming, 120V/277V

NA-None

<sup>1</sup> - Premium finishes may have extended lead times. Custom RALs are available, please consult Inside Sales with specific request.  
<sup>2</sup> - AWWNR/CSMB available upon request, contact Senso for details.

CONTACT FACTORY FOR MORE OPTIONS.

## Dimensions

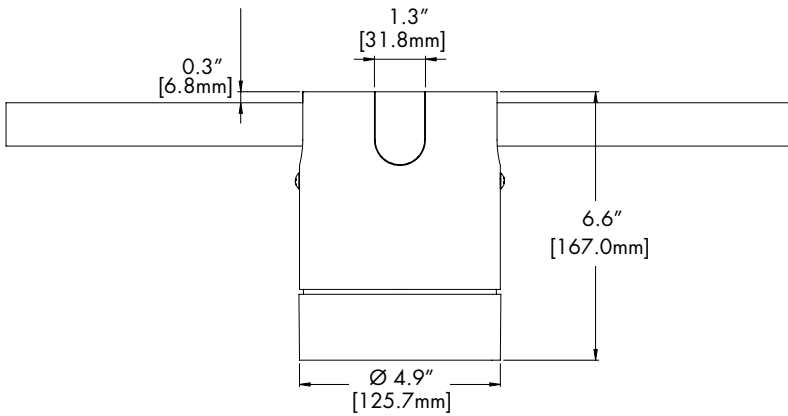

## Lens & Accessory Options

### OPTC-ACC-CL-94MM

#### Clear Lens

Also available with complete fixture, use ordering code.  
**-CL**



Light Loss Factor: 100%\*

### OPTC-ACC-DL-94MM

#### Diffusing Lens

Also available with complete fixture, use ordering code.  
**-DL**



Light Loss Factor: 87%\*

### OPTC-ACC-HC-94MM

#### Honeycomb Lens

Also available with complete fixture, use ordering code.  
**-HC**



Light Loss Factor: 45%\*

### OPTC-ACC-SL-94MM

#### Solite Lens

Also available with complete fixture, use ordering code.  
**-SL**



Light Loss Factor: 92%\*

\*Light Loss Factor calculated with 60° faceted reflector.

## Optics

### RFLC-FXX-94MM

#### Faceted Reflector

Also available with complete fixture, use ordering code.  
**-F10/-F18/-F30/-F45/-F60**



### RFLC-SXX-94MM

#### Smooth Reflector

Also available with complete fixture, use ordering code.  
**-S30/-S45/-S60**



FXX	Optic
F10	10° Faceted
F18	18° Faceted
F30	30° Faceted
F45	45° Faceted
F60	60° Faceted
S30	30° Smooth
S45	45° Smooth
S60	60° Smooth

## Remote Driver Housing

Depending on the options selected in the order code on page 1, a Remote Driver Housing may be required. This will automatically be generated and put on your order as necessary.

REMOTE DRIVER	MODEL	CCT	OUTPUT	DRIVER	DRIVER OPTIONS
HRM-Housing, Remote	LET115-SC-Leto 11.5 Surface Conduit	Same as Fixture	Same as Fixture	Same as Fixture	Same as Fixture

Maximum mounting distance to luminaire using 18 AWG wire						
010S	PHSD	010L	010G	DALI DALI8	DMX	LUTE
16'	16'	72'	72'	72'	149'	15'

### HRM Single with Externally Mounted Driver

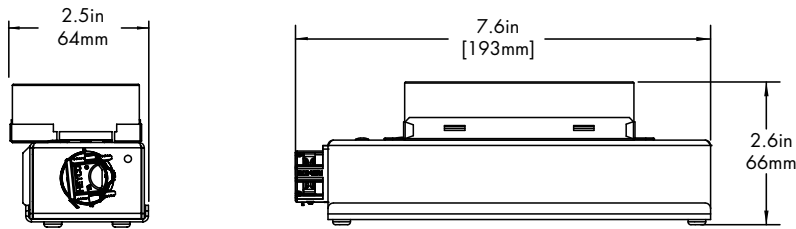

Driver
010L or 010G
010S
010L or 010G or 010S
DALI or LUTE

### HRM Single

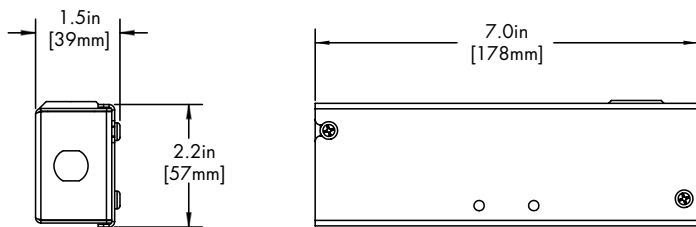

Driver
PHSD

### HRM Double

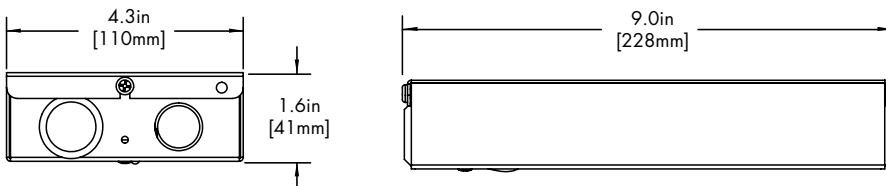

Driver
DALI8
DMX

### EMG Emergency Driver

120 minute EMG operation time.

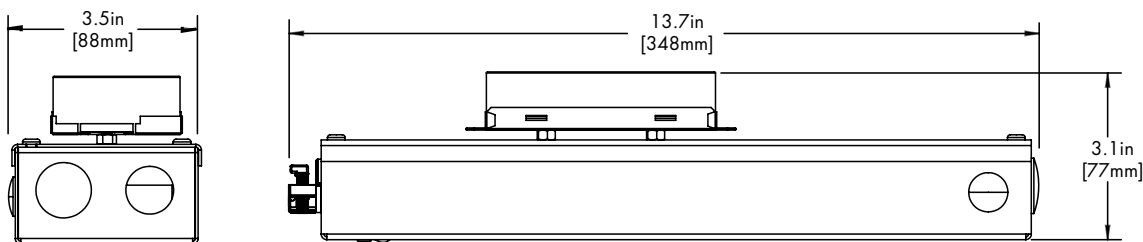

Driver
EMG

## Standard Finishes

**BK**  
Black



**WH**  
White



**SL**  
Silver



## Premium Finishes

**MA**  
Mocha



**CC**  
Charcoal



**CR**  
Cerulean

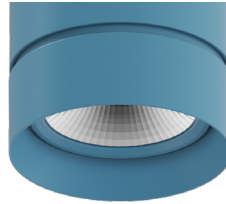

**FB**  
Firebrick

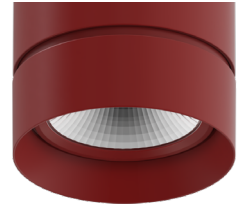

## Two Tone Baffle

Inside finish refers to Baffle Finish selection from page 1. Any combination may be used for baffle and body finishes.

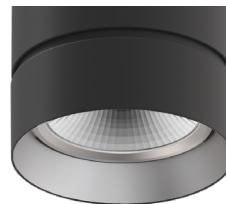
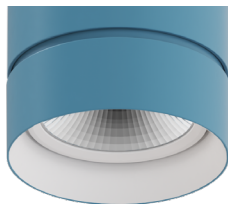
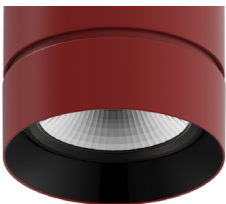

## TM-30

**2500K**

COLOR VECTOR GRAPHIC

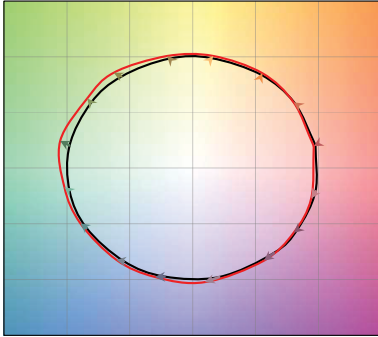

— Reference Source — Test Source

**2700K**

COLOR VECTOR GRAPHIC

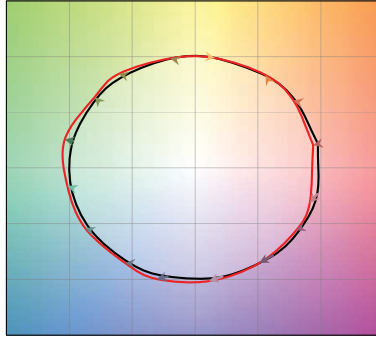

— Reference Source — Test Source

**3000K**

COLOR VECTOR GRAPHIC

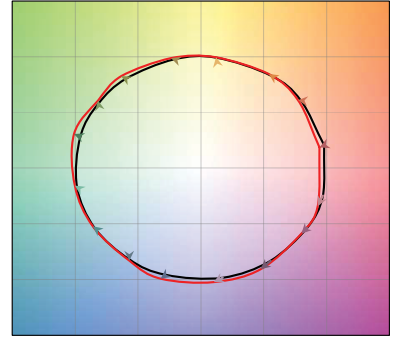

— Reference Source — Test Source

**3500K**

COLOR VECTOR GRAPHIC

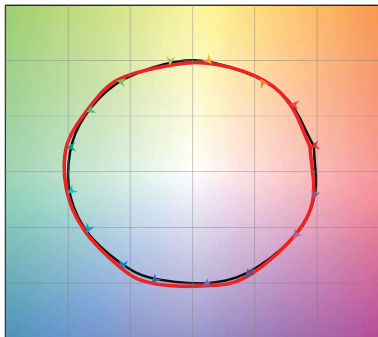

— Reference Source — Test Source

**4000K**

COLOR VECTOR GRAPHIC

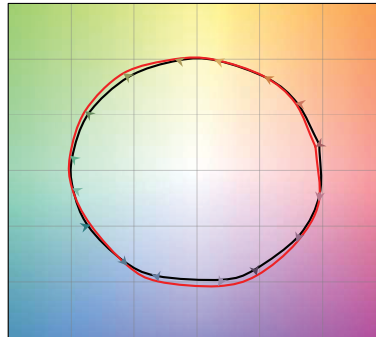

— Reference Source — Test Source

**6500K**

COLOR VECTOR GRAPHIC

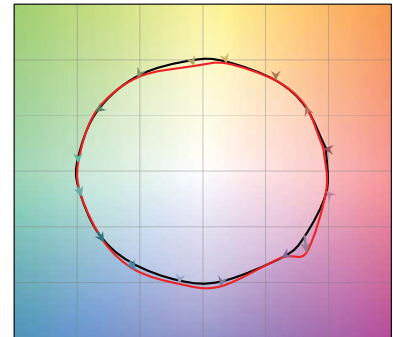

— Reference Source — Test Source

## Photometry

### 10° Faceted Reflector

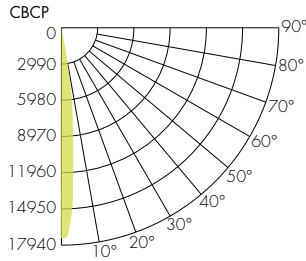
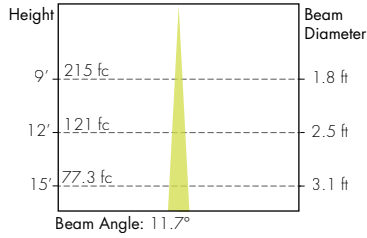

### 30° Smooth Reflector

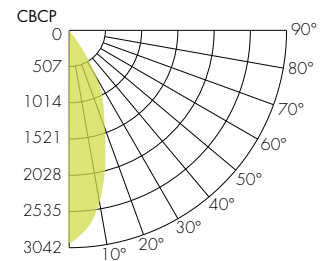
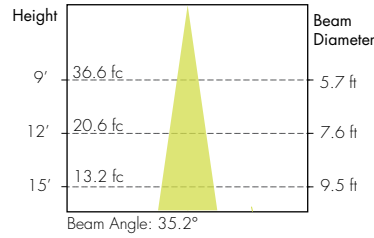

### 18° Faceted Reflector

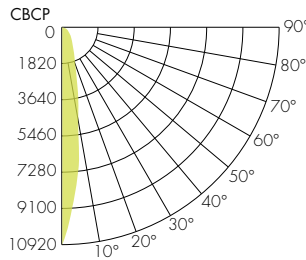
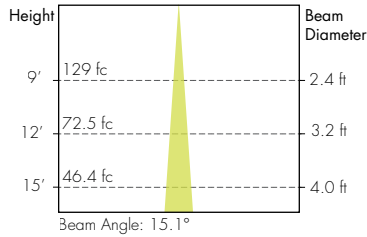

### 45° Smooth Reflector

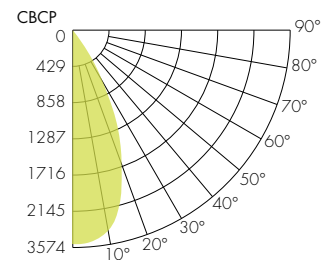
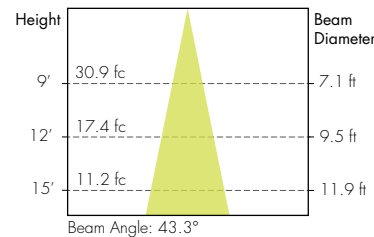

### 30° Faceted Reflector

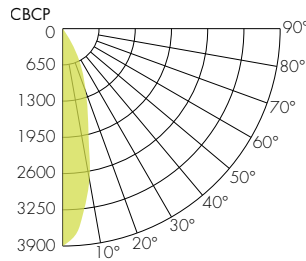
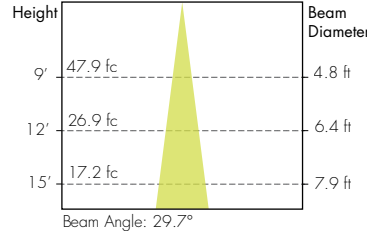

### 80° Smooth Reflector

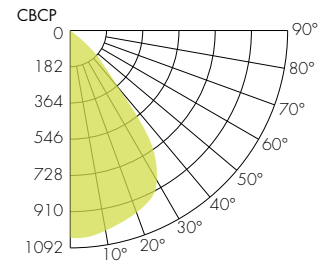
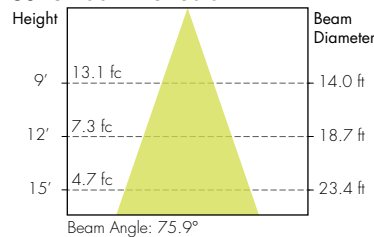

### 45° Faceted Reflector

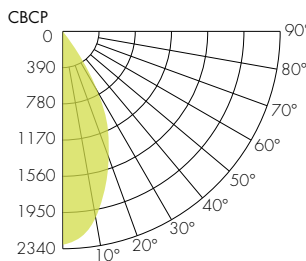
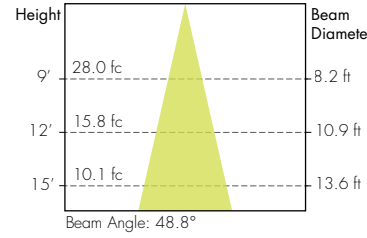

### 60° Faceted Reflector

