

# LETO 11

WALL MOUNT WET LED CYLINDER  
TUNABLE WHITE & WARM DIM



## Features

- Faceted and Smooth metal reflectors provide beam spreads between 10° to 80°.
- Nine drivers selections available to cover wide range of applications.
- Four output options available up to 2000 lumens.
- 5 year warranty.

## Finish Options

- White
- Mocha
- Black
- Charcoal
- Silver
- Cerulean
- Firebrick

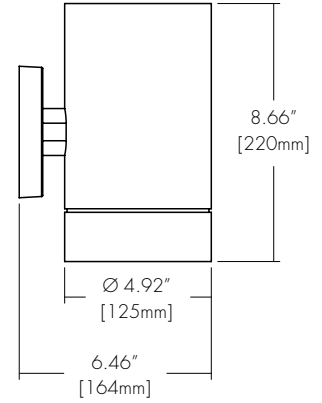

## Technical Information

TYPE	WD1830				TW2765	
	700 lm	1000lm	1500lm	2000lm	1500lm	2000lm
<b>OUTPUT OPTIONS</b>	700 lm	1000lm	1500lm	2000lm	1500lm	2000lm
<b>Fixture wattage</b>	7.6 W	11.2 W	16.2 W	21.2 W	16.4 W	21.73 W
<b>Delivered Lumen at full on</b>	713 lm	1072 lm	1563 lm	2006 lm	1500 lm	2002 lm
<b>Efficacy</b>	94 lm/W	96 lm/W	96 lm/W	95 lm/W	91 lm/W	92 lm/W
<b>Center Beam Candlepower (10° Faceted Reflector)</b>	5949 cd	8945 cd	13042 cd	16739 cd	12516 cd	16705 cd

CCT	CRI	TM-30		
		R <sub>f</sub>	R <sub>g</sub>	R <sub>9</sub>
1800K	94	90	93	61
3000K	94	89	97	72
2700K	91	90	96	59
6500K	93	87	97	73

Integral Driver Example: Fixture LET11W-WM-07-WD1830-F10-CL-WH-WH-PHSD-NA

Remote Driver Example: Fixture LET11W-WM-07-WD1830-F10-CL-WH-WH-010L-NA  
HRM-LET11W-WM-07-WD1830-010L-NA

## Ordering Code

### Fixture

MODEL	TYPE	OUTPUT	CCT	OPTIC	ACCESSORY	BODY FINISH	BAFFLE FINISH
LET11W - Leto 11 Wet	WM - Wall Mount	07 - 700 lumens <sup>1</sup> 10 - 1000 lumens 15 - 1500 lumens 20 - 2000 lumens	WD1830 - Warm Dim, 1800K-3000K TW2765 - Tunable White, 2700K-6500K <sup>6</sup>	F10 - 10 Degree, Faceted F18 - 18 Degree, Faceted F30 - 30 Degree, Faceted F45 - 45 Degree, Faceted F60 - 60 Degree, Faceted S30 - 30 Degree, Smooth S45 - 45 Degree, Smooth S80 - 80 Degree, Smooth	CL - Clear Lens DL - Diffusing Lens	<b>Standard</b> WH - White BK - Black SL - Silver  <b>Premium<sup>2</sup></b> MA - Mocha CC - Charcoal CR - Cerulean FB - Firebrick	<b>Standard</b> WH - White BK - Black SL - Silver  <b>Premium<sup>2</sup></b> MA - Mocha CC - Charcoal CR - Cerulean FB - Firebrick
DRIVER <sup>3</sup>			DRIVER OPTIONS <sup>5</sup>				

PHSD - Forward/Reverse Phase, 1% Dimming, 120V Only  
 010S - 0-10V, 1% Dimming, 120/277V  
 0103 - 0-10V, 1% Dimming, 347V Only  
 010L - EldoLED, 0-10V, Linear, 0.1% Dimming, 120/277V  
 010G - EldoLED, 0-10V, Log, 0.1% Dimming, 120/277V  
 DALI - EldoLED, DALI Protocol 2, DT-6, 0.1% Dimming, 120/277V  
 DALI8 - EldoLED, DALI Protocol 2, DT-8, 0.1% Dimming, 120/277V  
 LUTE - Lutron HiLume Ecodigital, 1% Dimming, 120V/277V  
 DMX - EldoLED, DMX, 0.1% Dimming, 120V/277V

NA - None  
EMG - Emergency Driver<sup>4</sup>

1 - 700 lumens is not available with LUTE driver.  
 2 - Premium finishes may have extended lead times. Custom RALs are available, please consult Inside Sales with specific request.  
 3 - All drivers remote except PHSD/010S driver options  
 4 - Emergency option comes prewired from factory with driver in remote housing. 8W of continuous power provided for a minimum of 90 minutes. Must be installed within 30 feet of luminaire using 18 AWG wire. Not available with 0103, DMX, DALI8 or LUTE Driver.  
 5 - AWNR/CSMB available upon request, contact Senso for details.  
 6 - TW2765 only available with 15/20 lumens and 010L/010G/DALI8/DMX. Always remote mounted. Cannot use with EMG.

CONTACT FACTORY FOR MORE OPTIONS.

# LETO 11

WALL MOUNT WET LED CYLINDER  
TUNABLE WHITE & WARM DIM

## Lens & Accessory Options

### OPTC-ACC-CL-94MM

Clear Lens

Also available with complete fixture, use ordering code.

**-CL**



Light Loss Factor: 100%\*

### OPTC-ACC-DL-94MM

Diffusing Lens

Also available with complete fixture, use ordering code.

**-DL**



Light Loss Factor: 87%\*

\*Light Loss Factor calculated with 60° faceted reflector.

## Optics

### RFLC-FXX-94MM

Faceted Reflector

Also available with complete fixture, use ordering code.

**-F10/-F18/-F30/-F45/-F60**



### RFLC-SXX-94MM

Smooth Reflector

Also available with complete fixture, use ordering code.

**-S30/-S45/-S60**



FXX	Optic
F10	10° Faceted
F18	18° Faceted
F30	30° Faceted
F45	45° Faceted
F60	60° Faceted
S30	30° Smooth
S45	45° Smooth
S60	60° Smooth

# LETO 11

WALL MOUNT WET LED CYLINDER  
TUNABLE WHITE & WARM DIM

## Remote Driver Housing

Depending on the options selected in the order code on page 1, a Remote Driver Housing may be required. This will automatically be generated and put on your order as necessary.

REMOTE DRIVER	MODEL	CCT	OUTPUT	DRIVER	DRIVER OPTIONS
HRM-Housing, Remote	LET11W-WM-Leto 11 Wet Wall Mount	Same as Fixture	Same as Fixture	Same as Fixture	Same as Fixture

Maximum mounting distance to luminaire using 18 AWG wire						
010S	PHSD	010L	010G	DALI DALI8	DMX	LUTE
16'	16'	72'	72'	72'	149'	15'

### HRM Single with Externally Mounted Driver

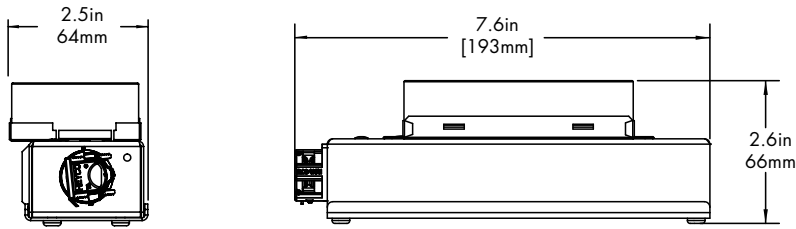

Driver
010L or 010G
010S
010L or 010G or 010S
DALI or LUTE

### HRM Single

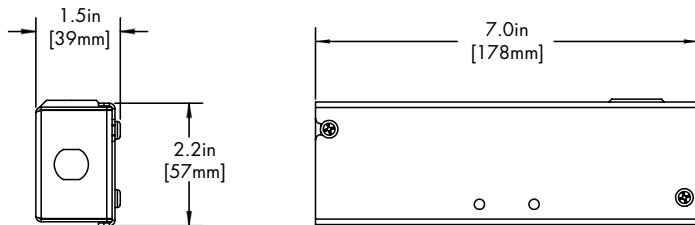

Driver
PHSD

### HRM Double

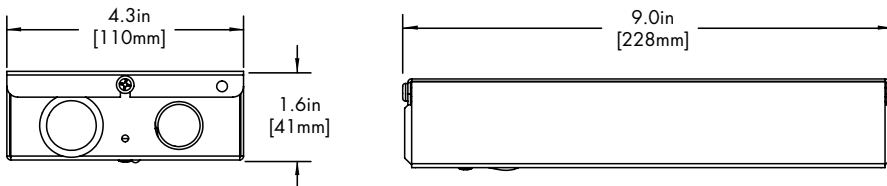

Driver
DALI8
DMX

### EMG Emergency Driver

120 minute EMG operation time.

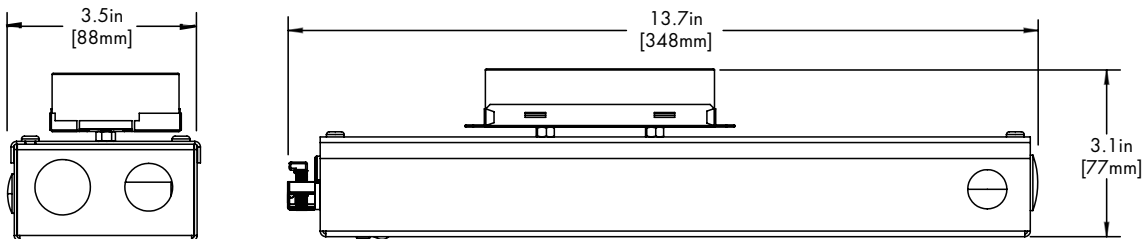

Driver
EMG

# LETO 11

WALL MOUNT WET LED CYLINDER  
TUNABLE WHITE & WARM DIM

## Standard Colors

**BK**  
Black



**WH**  
White



**SL**  
Silver



## Premium Colors

**MA**  
Mocha

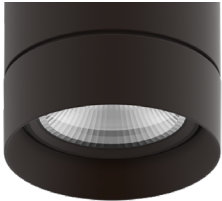

**CC**  
Charcoal

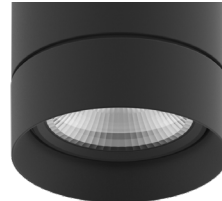

**CR**  
Cerulean

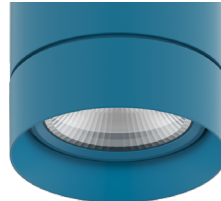

**FB**  
Firebrick

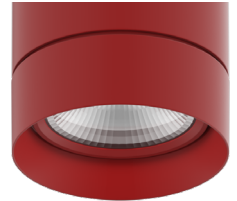

## Two Tone Finishes

Inside finish refers to Baffle Finish selection from page 1. Any combination may be used for baffle and body finishes.

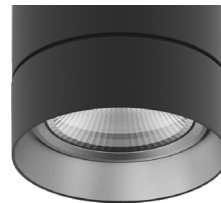
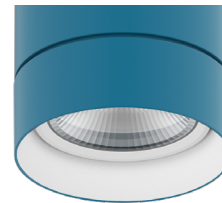
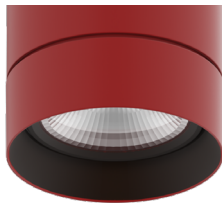

# LETO 11

WALL MOUNT WET LED CYLINDER  
TUNABLE WHITE & WARM DIM

## TM-30

Warm Dim 1800K

COLOR VECTOR GRAPHIC

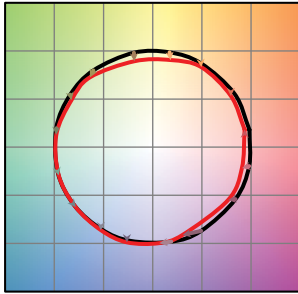

— Reference Source — Test Source

Warm Dim 3000K

COLOR VECTOR GRAPHIC

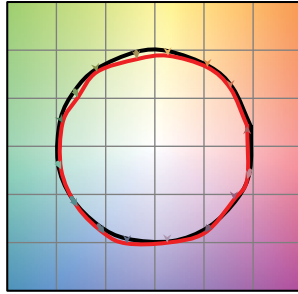

— Reference Source — Test Source

Tunable White 2700K

COLOR VECTOR GRAPHIC

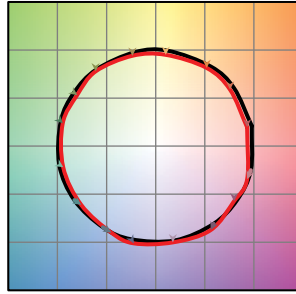

— Reference Source — Test Source

Tunable White 6500K

COLOR VECTOR GRAPHIC

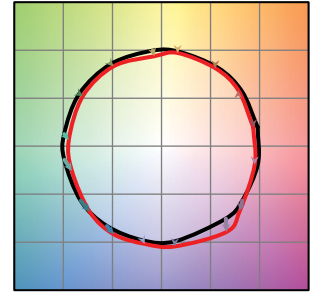

— Reference Source — Test Source

# LETO 11

WALL MOUNT WET LED CYLINDER  
TUNABLE WHITE & WARM DIM



## Photometry

### 10° Faceted Reflector

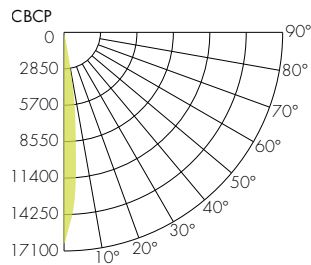
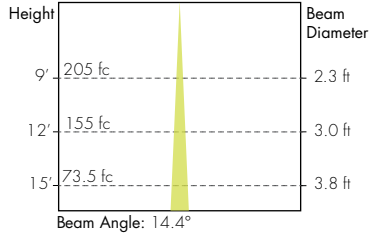

### 30° Smooth Reflector

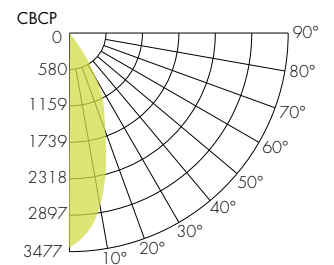
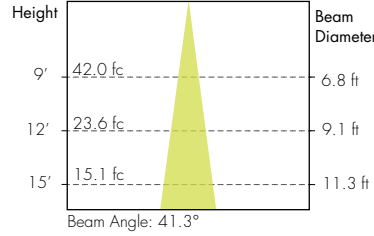

### 18° Faceted Reflector

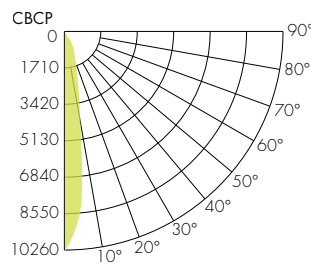
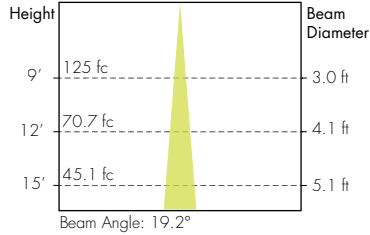

### 45° Smooth Reflector

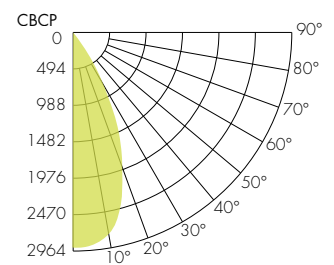
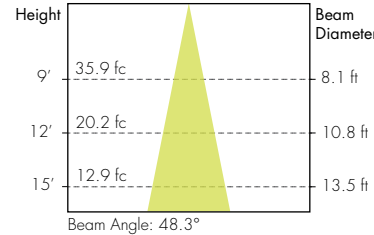

### 30° Faceted Reflector

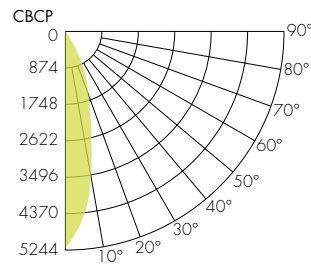
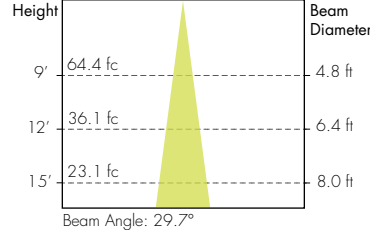

### 80° Smooth Reflector

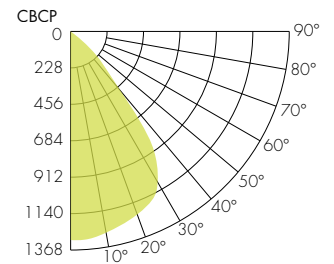
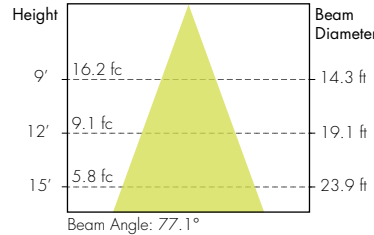

### 45° Faceted Reflector

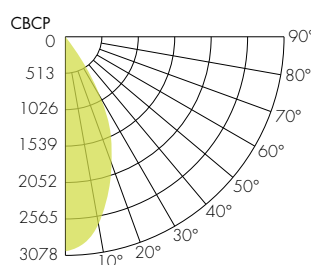
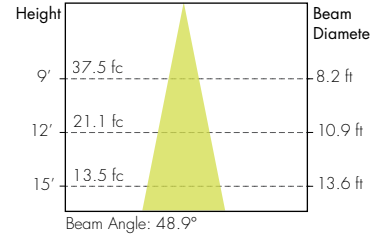

### 60° Faceted Reflector

